

2017/06/09
 MICOKit-3047 V1.0 初始文档
 2017/07/09

MICOKit-3027 V1.1
 1, 模块19脚 GPIOA_7取消, 去掉GPIOA_7的开关SW1
 2, 增加 TES connector的VDD GND接口
 3, 修改 HTS221TR, LSM6DSL的封装

2017/0728
 1, 增加RESET处电阻R18 (27R)
 2, 增加六轴传感器5脚处C14 (100nF) 滤波电容
 3, J2、J3增加一GND引脚, 由3PIN改为4PIN

2017/08/04
 1, 修改HTS221TR封装, 修改R12封装, 修改电机封装

2017/9/29
 1、增加六轴传感器SPI线上面的22R电阻
 2、优化六轴传感器封装

A

B

C

D

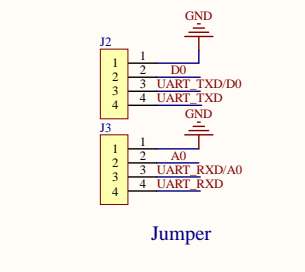
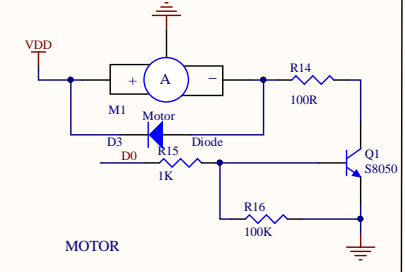
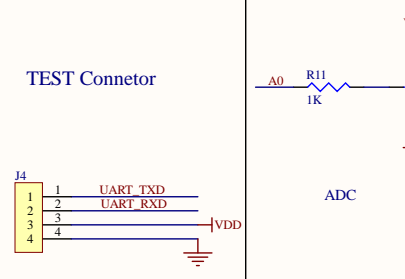
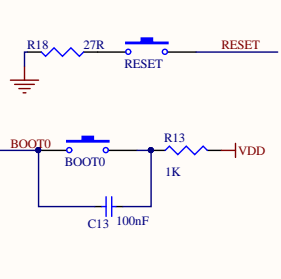
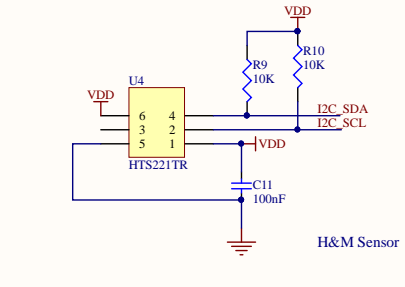
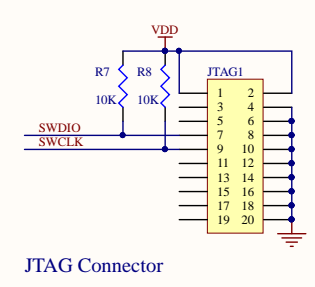
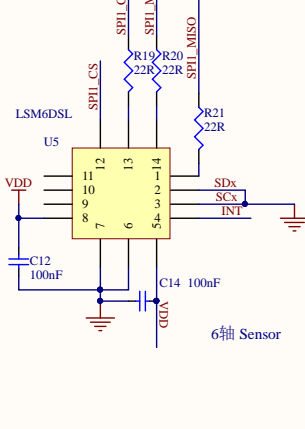
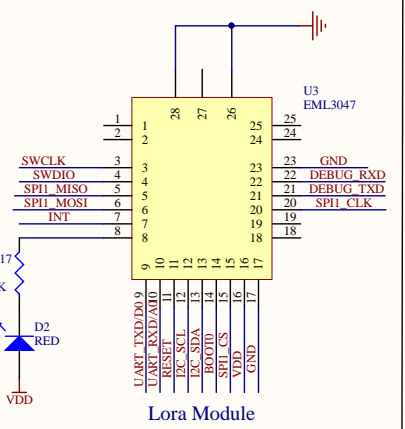
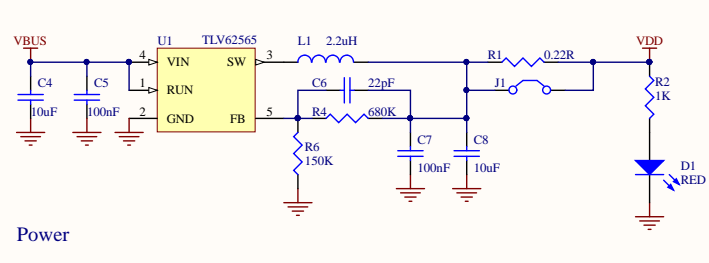
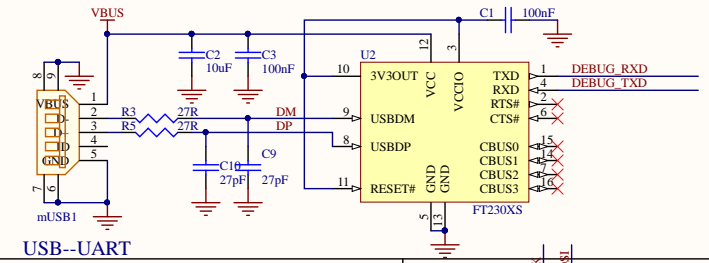

Title: Micokit_3047		MXCHIP® 上海庆科信息技术有限公司		
Designer: dusong	Verifier: Liuzuoqin	Shanghai MXCHIP Info Tech Co., Ltd.		
Approver: Likeren	Size: A4			Ver: *
Data: *	Sheets: 1 of 1			Secrecy: Y

A

B

C

D